



3181 DIGITAL POWER HI TESTER  
3171 DIGITAL PRINTER

3 1 8 1  
3 1 7 1

power consumption,  
voltage and current,  
plus integrated power measurements

**Straight from the equipment line cord**



**HIOKI** MODEL 3181  
POWER METER

DIGITAL POWER HI TESTER  
INTEGRATOR

1999 W A V  
99.9999 kWh

POWER

START HOLD RUN HOUR MINUTE TIME SET

RANGE	WATT	AC A	AC V
Hi	2000W	20A	200V
Lo	200W	2A	200V

05-125V1

HIOKI E. E. CORPORATION JAPAN



# The ideal system for efficiency evaluation and inspection

The Model 3181\* is a compact, lightweight instrument designed to measure power consumption and/or integrated power in electrical equipment and household appliances by simply plugging the device into the unit. Its multifunction features also let you obtain separate voltage and current measurements.

\*The Model 3181-01 uses terminal connectors.

## The importance of integrated power measurements

Many household appliances – air-conditioners and refrigerators being two common examples – vary considerably in power consumption characteristics depending on the ambient temperature. An extremely effective way to evaluate their efficiency is to simply run an integrated power measurement over a

given period of time, under conditions prescribed beforehand. The 3181 reports up to 1,000kWh on its 6-digit LCD.



Easy-to-understand integration model 3171 c

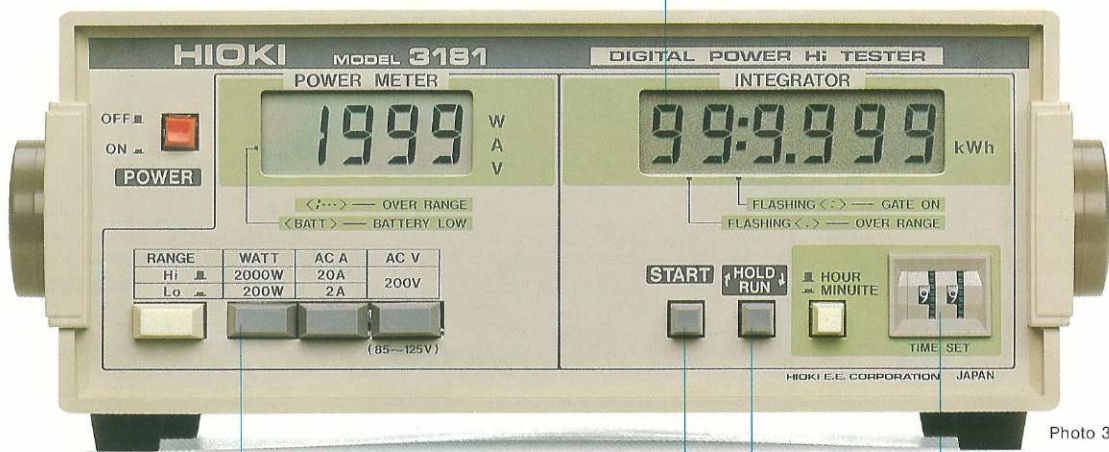

Photo 3181

## Power consumption, Voltage/Current measurements

Power, voltage or current is selected by pressing the appropriate Function Switch, with measurement results output to a 3 1/2-digit LCD.

AC voltage and current are quantified by the true root-mean-square (TRMS) method for accurate measurement of distorted waveforms typically produced by thyristor-controlled equipment.

## Integrator START button

## Integrator display HOLD and RUN function

Pressing this push-push switch allows the display to be stopped (HOLD) for easy viewing. The internal counter continues to increment however, and when the switch is pressed again (RUN), the display is updated to the present integration value.

## Timer function

The timer lets you set the integration interval from 1 to 99 minutes, or from 1 to 99 hours.

## Terminal connector type instrument allows measurements to be made on equipment operated at up to 250VAC Model 3181-01

This instrument measures the various operating characteristics of electrical equipment and appliances by connecting the power lines of the device directly to input terminals on the 3181-01. Test circuit range is expanded to 0 – 250VAC. A Voltage Selector is also provided on the rear panel of 3181-01, permitting it to be operated from 100, 120, 220, or 240V sources.

## Simultaneous recording of power, voltage, and current measurements

Separate output terminals are provided for each measurement function, allowing you to connect individual recorders for monitoring changes occurring at various points in a machine cycle.

## Direct AC line cord plug-in

All measurements are made by plugging the line cord of the device directly into Model 3181.

## Data protected through power failures (Battery back-up)

Three size AA (SUM-3) batteries are used to protect the integration data (and the display) in the event of a power failure.

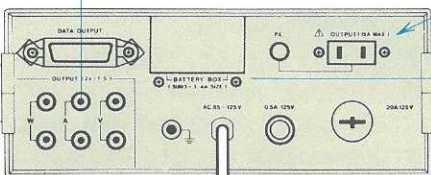

Power supply (85 ~ 125VAC)

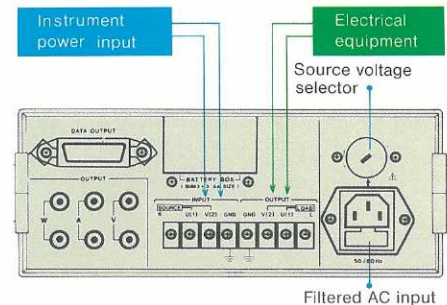



# on of household appliances, air conditioning units etc.

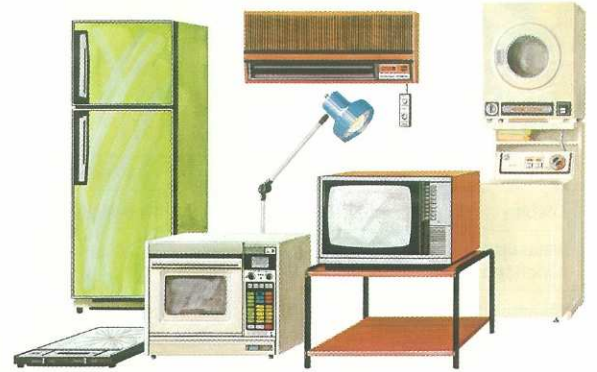
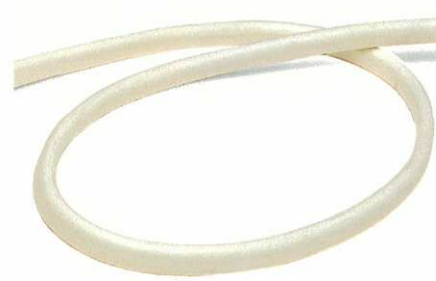

## Hard-copy feature makes monitoring procedures easier

Modest system expansion is available by interfacing the Model 3171 Digital Printer. Hard-copy results of integrated power values may thus be obtained for permanent records.

## Time-interval print-out

Print-out may be set to occur at any interval ranging from one to 99 minutes. The increment unit is one minute. A "00" setting allows print to be executed manually.

## Double-duty handle

The bucket-bail type handle is free rotating (360°) and may be locked in 12 different positions for the best viewing angle. (same as 3181)

and print-out  
ita via the  
tal printer

## Battery alarm indicator

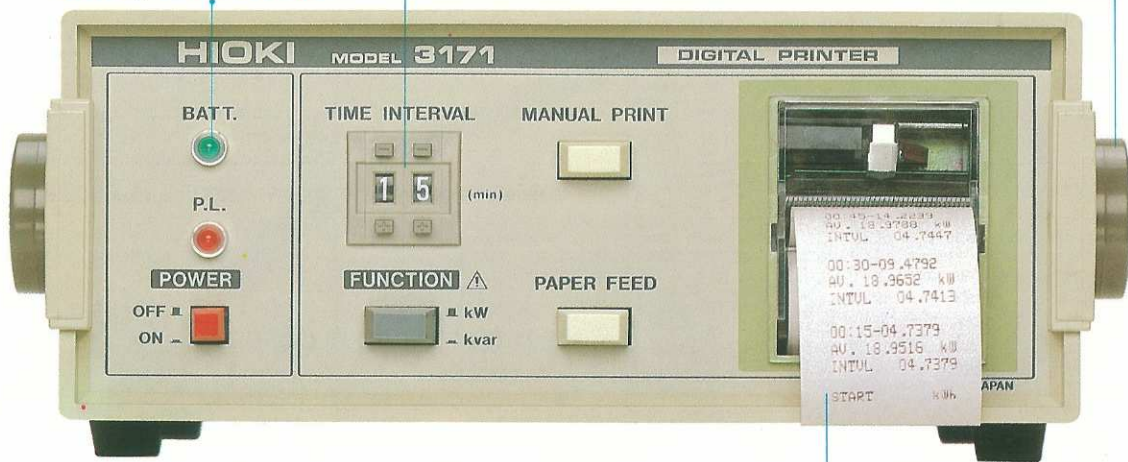

## External print terminal

Print-out executed via signal input from external controller. Data is current at the point of terminal closure. Convenient for equipment electrical characteristics testing timed to a machine cycle.

## Wide selection of print functions

Approximately 2280 lines can be printed on one roll of recording paper. Print functions include elapsed time, cumulative integrated power, integrated

power over a set interval (averaged), and appropriate comments.

Comments are: START, INTVL, MANUAL, EXT. PRINT, AV, OVER, ov, and ERROR.

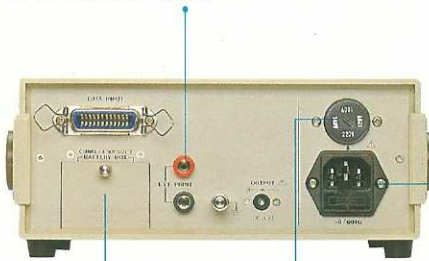

## Battery back-up

## Source voltage selector

Permits the 3181/3171 to be operated in any area of the world your operations take you.

## Filtered AC input

A line filter prevents power source noise from affecting the accuracy of the data. Concern for operator safety is also evidenced by the fuse requiring the unit to be unplugged prior to changing.



Cumulative integrated power (kWh) occurring between 00:00 and 00:45 min. printed out on the same line as elapsed time.

Average power (kW) consumed in the interval between 00:30 and 00:45 min. calculated as present data (00.1303) minus previous data (00.0869) times 60/15 (min.).

Integrated power (demand) in kWh between 00:15 and 00:30 min.

3181 START button pressed. . . . START and kWh printed as comments. (3171 Function Selector: kW)

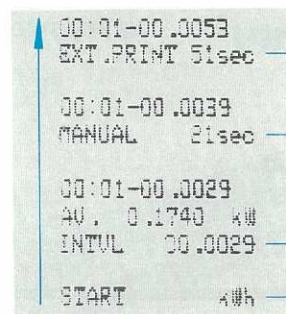

3171 EXT. PRINT terminal closed. . . . EXT. PRINT is printed as comment accompanying elapsed time (in seconds) and integrated power.

3171 MANUAL PRINT button pressed. . . . MANUAL is printed as the comment accompanying elapsed time (in seconds) and integrated power.

Normal Time Interval Print-Out

3181 START button pressed.



## Specifications

### 3181-01 (Data in brackets [ ] for 3181)

	Power meter	Integrator
Display	3½-digit LCD	6-digit LCD
Measurement functions	Single-phase effective power AC voltage; AC current	Integrated power
Measurement range	Power: 200/2000W Current: 2/20A Voltage: 0~250V [85~125V]	10 <sup>2</sup> kWh/10 <sup>3</sup> kWh
Accuracy (at 50/60Hz 23°C ±5°C cos φ = 1)	Power: ±0.5% rdg. ±0.3% f.s. Current: ±0.5% rdg. ±0.3% f.s. Voltage: ±0.7% rdg. ±1 dgt.	±1% rdg. ±1 dgt. (at ¼ to ⅙th of f.s.)
Frequency response (at 40~500Hz cos φ = 1)	Power: within ±1% Current/Voltage: within ±0.5%	
Power factor induced error	less than ±0.8% rdg. (at cos φ = 0.5)	
Temperature Characteristics (at 0~40°C)	less than ±0.1% f.s./°C	less than ±0.5% f.s./°C
Max. Test circuit voltage	250V rms [125V rms]	
Rated current	15A rms (continuous)	
Crest factor	Power/Current: the lower value of <2 (at rated value) or 30A peak value; Voltage: <500V peak value [ <250V peak value]	
Output terminal	2V DC output for 200V input (voltage only) [2V DC/f.s.]	Hi: 5V Lo: 0V CMOS logic
Power source	AC100, 120, 220, 240V ±15% 50/60Hz [AC85~125V, 50/60Hz approx. 3.5W]	
Power source induced error	Above specifications accurate at power source specifications	
Back-up source	Three size AA (SUM-3) batteries (will hold memory contents over 100 hr. continuous service)	
Dimensions/Weight	85H×250W×220D mm/approx. 2.6kg	
Accessories	[Fuse 0.5A 1 ea.] Line cord 1 ea.	

Standard packing (Double carton box)	Model	Sets	N.W.	G.W.	cft
	3171	3	12 kg	14 kg	3.3
	3181/3181-01	3	9 kg	11 kg	3.3



### 3171 DIGITAL PRINTER

Printing method: 5 × 7 dot-matrix thermal printer, 15 cpl.  
Recording paper: 38mm × 8m roll; Max. dia of roll: 26.5mm;  
Black print

Print functions: Time (23 hours 59 min. 59 sec.);  
Cumulative integrated power;  
Power occurring over an interval (amount of demand);  
Average power at specified interval;  
Appropriate comments (START, EXT. PRINT, MANUAL, OVER, ov, ERROR, INTVL, AV.)  
Appropriate units (kW, kWh, sec.)

Operating functions: Paper feed; Manual print; Time interval (1 ~ 99 min.);  
Unit selection (Watt-var)

Accessory functions: External print terminal: DC 6V output terminal  
Power failure battery back-up; Ground terminal;  
Source voltage selector

Power requirements: 100, 120, 220, or 240V AC (50/60Hz)  
Printing consumption: approx. 10W;  
Idle consumption: approx. 7.7W

Accessories: Connector cable, 1 ea.; Line cord, 1ea.;  
Carrying case 1ea.;  
9220 thermal recording paper, 1 box (5 rolls)

Dimensions/Weight: 85H × 250W × 220D mm/approx. 2.6 kg

### 8201-8202 MICRO HI CORDER

- Compact, lightweight electrical discharge recorder.  
Dot speed has been increased to a fast 32 dots per second for extremely good response to input fluctuations.
- 1MΩ input impedance.
- Speed selectable in 5 steps.

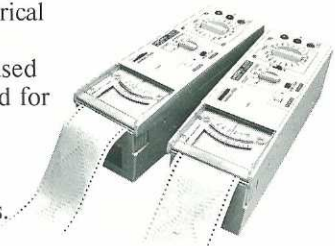

Measurement range:  
8201: 10mV~50V DC - 0.1mA~10mA DC  
8202: 0.1V~500V DC/AC - 1mA~100mA AC/DC

Line voltage requirements:  
8201-00 - 8202-00: 110V~120V, 210V~230V, 230V~250V, 50/60Hz AC  
8201-01 - 8202-01: 110V~120V, 210V~230V, 230V~250V, 50/60Hz AC or 12V DC (approx. 7W)

Dimensions/Weight: 94H×96W×280L mm/approx. 1.7 kg

## HIOKI E.E. CORPORATION

DISTRIBUTED BY

**Head Office:** P.O. Box 1, Sakaki, Nagano, 389-06 Japan  
Tlx: 3327508 HIOKI J/Cable: HEWLOV, Ueda  
Telephone: (02688) 2-3030

**Tokyo Office:** 2-23-24 Shiba Nakata, Kawaguchi, Saitama 333  
Telephone: (0482) 61-2401

**Hioki New York Corp.:** P.O. Box 275 Douglaston, N.Y. 11363, U.S.A.  
Telephone: (212) 224-2404

All specifications are subject to change without notice.

3181E1-22E-05K Printed in Japan